

ME238

Three-phase multifunctional smart meter With RJ45 Easy Connection

V1.0



Catalogue

1. Product description.....	1
2. Data display.....	4
3. Accuracy and certification.....	5
4. Connection.....	6
4.1. Power supply.....	7
4.2. Voltage and current input.....	7
4.3. RS485.....	8
4.4. Relay output.....	8
4.5. Digital output.....	9
4.6. Electric energy pulse output.....	9
5. Operation and interface display.....	10
5.1. Display and key.....	10
5.2. Meter start interface.....	12
5.3. Meter display mode switching.....	12
5.4. Real time measurement data display interface.....	13
5.5. Power quality display interface.....	14
5.6. Electric energy display interface.....	17
5.7. Equipment information display interface.....	18
5.8. Equipment configuration display interface.....	19



1. Product description

ME238 three-phase multi-functional panel meter supports external 333mV CTs and Flexible Rogowski coil with **RJ45 terminal easy to install.**

ME238 supports 3PH3W and 3PH4W system; it can measure Current, Voltage, Power Factor, Harmonic, Power, Energy and other electrical parameters of L1, L2, L3.

Description					
Type	96*96 Panel Meter				
Poles description	3PH3W ,3PH4W.				
Application	Current, Voltage, Power, Energy and harmonic measurement				
display screen	3.8 inch LCD segment code display screen.				
Weight	259g				
Dimension	L*W*D: 8.1*8.1*3CM				
Color	White and black				
Model	ME238				
Current sensor type	333mV CT and Rogowski coil				
Advantage	3 IN 1 current sensor with RJ45 port easy to install				
Current					
Model	ME238				
Primary Rated current	5A	100A	600A	2500A	6000A
Secondary Rated input	333mV		50mV/kA@50Hz	85mV/kA@50Hz	50mV/kA@50Hz
Input channel maximum value	500mV				
Current measurement Range	0.005~5A	0.5A to 100A	2A to 600A	2.5A to 2500A	6A to 6000A
Recommended Sensor model	STP-5	STP-100 or STP-100R	STP-600	STP-2.5K	STP-6K
STP-5	3 IN 1 RJ45 Split core CTs (O.D.10mm)				

<p>STP-100</p>	<p>3 IN 1 RJ45 Split core CTs (O.D.16mm)</p>	<p>MEATROL[®] ELECTRICAL STP-100</p> 
<p>STP-100R (Choice STP-100R when STP-100 can't not be easy to install)</p>	<p>3 IN 1 RJ45 Rogowski Coil +Integrator (O.D.24mm)</p>	<p>MEATROL[®] ELECTRICAL STP-100R</p> 
<p>STP-600</p>	<p>3 IN 1 RJ45 Rogowski Coil (O.D.36mm)</p>	<p>MEATROL[®] ELECTRICAL STP-600</p> 

STP-2.5K	3 IN 1 RJ45 Rogowski Coil (O.D.150mm)	 <p>MEATROL[®] ELECTRICAL STP-2.5K</p>
STP-6K	3 IN 1 RJ45 Rogowski Coil (O.D.200mm)	 <p>MEATROL[®] ELECTRICAL STP-6K</p>
Voltage		
Range	0~600VAC Phase to Phase Voltage	
Maximum range	720VAC Phase to Phase Voltage	
Digital Signal		
Energy pulse output	Active energy pulse output, optocoupler isolation (5kvrms)	
Relay output	One way electromagnetic relay output, including normally open and normally closed contacts, contact capacity: 3A 30V DC, 3A 250V AC	
Digital input	2-way dry contact input, optocoupler isolation (5kvrms)	
Communication		
RS485 communication	One way RS485 communication interface Interface type: two wire half duplex Communication baudrate: 2400bps ~ 19200bps Protocol: Modbus RTU	
Power supply		
Power Supply	95~265VAC/110~260VDC, 45~60Hz	
Maximum power consumption	3.5VA	

The standard RS485 communication interface can be compatible with various configuration systems through the standard MODBUS-RTU protocol.

2. Data display

Measuring data	
Phase Voltage	U1, U2, U3 and average value.
Line Voltage	U12, U23, U31 and average value.
Current	I1, I2, I3 and average value.
Power	Active power, Reactive power, Apparent power (total and per phase).
Energy	Active energy import, active energy export, reactive energy import, reactive energy export, apparent energy. If it exceeds 9999999.9kwh, the energy value will be reset to "0" automatically.
Harmonic	The total harmonics of each phase of voltage and current.
Power Factor	Including power factor PF and fundamental power factor DPF (average value of each phase and three phases)
Grid Frequency	Synthetic frequency
Update rate	
Data refresh rate	500ms
Harmonic	
Voltage	Total harmonic phase
Current	Total harmonic phase
Max / min	
Voltage	Per phase
Current	Per phase
Power	Active power, Reactive power, Apparent power (sum of all phases and three phases)
Unbalance degree	
Voltage	Per phase
Current	Per phase
Demand / maximum demand	
Current	Per phase
Power	Active power, Reactive power, Apparent power (sum of all phases and three phases)

3. Accuracy and certification

Note: RDG: reading value, FS: full scale

Measuring accuracy	
Model	ME238
Current measurement	±0.5%RDG
Guarantee range of current measurement accuracy	1% FS~100%FS
Voltage measurement accuracy	0.2%(30~600V AC)
Grid frequency	0.01%(45~65Hz)
Power factor	±0.005
Active and apparent power	IEC62053-22 level 0.5S
Reactive power	IEC62053-21 level 2S
Active energy	IEC62053-22 level 0.5S
Reactive energy	IEC62053-21 level 2S
Environment condition	
Operating temperature	-25℃~+60℃
Storage temperature	-40℃~+85℃
Humidity range	5~95% RH, 50℃(non-condensing)
Class of pollution	2
Over voltage capability	CAT III 1000V, It is suitable for distribution system below 277 / 480VAC
Insulation strength	IEC61010-1
Altitude	3000m Max
Antipollution level	IP20 (Meet the standard of IEC 60629)
Quality guarantee period	12 months
EMC (electromagnetic compatibility)	
Electrostatic discharge	Level CAT IV 600V (IEC61000-4-2)
Radiated immunity	Level CAT III 1000V (IEC61000-4-3)
EFT Electrical fast burst immunity	Level CAT IV 600V (IEC61000-4-4)
Surge immunity	Level CAT IV 600V (IEC61000-4-5)
Conducted disturbance immunity	Level CAT III 1000V (IEC61000-4-6)
Power frequency magnetic field immunity	0.5mT (IEC61000-4-8)
Conduction and radiation	Class B (EN55022)
Measurement standard	
EN 62052-11, EN61557-12, EN 62053-21, EN 62053-22, EN 62053-23, EN 50470-1, EN 50470-3, EN 61010-1, EN 61010-2, EN 61010-031	

4. Connection

The meter is equipped with rich interfaces to realize different functions.

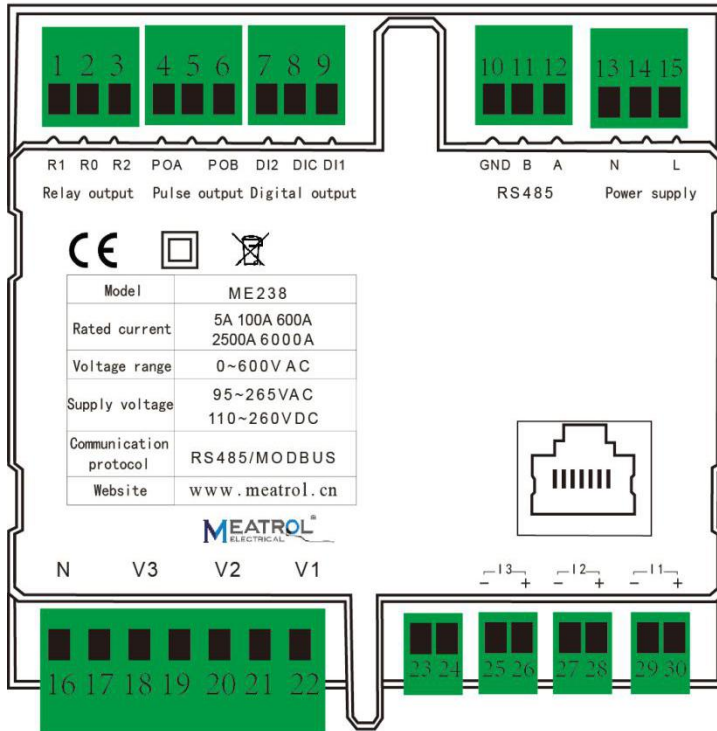

Point number	Point type	Point name	Point function	Remarks
1	Relay output	R1	Relay normally open contact	One relay output with normally open and normally closed contacts
2		R0	Relay common contact	
3		R2	Relay normally closed contact	
4	Pulse output	POA	Positive end of pulse output	Active power pulse output
5		N/C	N/A	
6		POB	Pulse output negative terminal	
7	Relay output	DI2	Digital input channel 2	One relay output with normally open and normally closed contacts
8		DIC	Digital channel common terminal	
9		DI1	Digital input channel 1	
10	RS485	GND	RS485 communication GND	RS485 communication
11		B	RS485 communication B	
12		A	RS485 communication A	
13	Power supply	N	Power supply (-)	Range 95~265VAC/110~260VDC, 45~60Hz
14		N/C	N/A	
15		L	Power supply (+)	
16	Voltage input	N	N-phase voltage input	Measurement voltage input channel
17		N/C	N/A	
18		V3	Phase C voltage input	
19		N/C	N/A	
20		V2	Phase B voltage input	
21		N/C	N/A	
22	V1	Phase A voltage input	ME238 Current channel interface.	
23	N/C	N/A		
24	N/C	N/A		
25	N/C	N/A		
26	N/C	N/A		
27	N/C	N/A		
28	N/C	N/A		
29	N/C	N/A		
30	N/C	N/A		
31	RJ45	A B C three phase current input		

4.1. Power supply

The meter adopts external power supply mode, without internal direct power supply. The power supply voltage range is 95 ~ 265VAC / 110 ~ 260VDC, 45 ~ 60Hz, and the maximum power consumption is 3.5VA.

- Do not connect the meter with the cable live.
- Before connecting the power supply, make sure that the power supply voltage is within the required range, otherwise the meter can not work normally.

4.2. Voltage and current input

The meter supports two wiring modes, three-phase four wire (3P4W) and three-phase three-phase (3P3W)

- The actual wiring mode of the meter must be consistent with that of the internal configuration of the meter.
- Three phase four wire requires three current sensors.
- Two or three current sensors are required for three-phase three wire system. The use of two current sensors does not affect the measurement of power and electric energy, but the current of phase B cannot be measured. Three current sensors can be used to measure phase B current.
- The phase sequence of voltage and current must follow the phase sequence of ABC, otherwise the meter will display the phase sequence error of voltage and current.
- When using the current sensor, the direction of the current arrow on the sensor must be consistent with the actual current flow direction, that is, the current arrow of the sensor points to the load end.

4.2.1. ME238 voltage and current wiring mode is as follows:

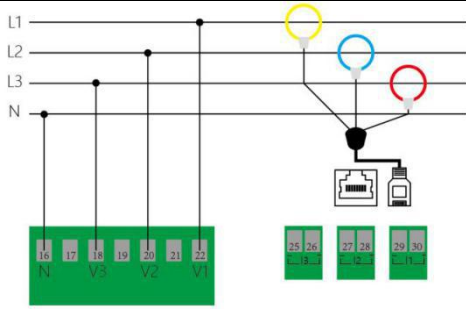

3PH4W(without PT) wiring diagram

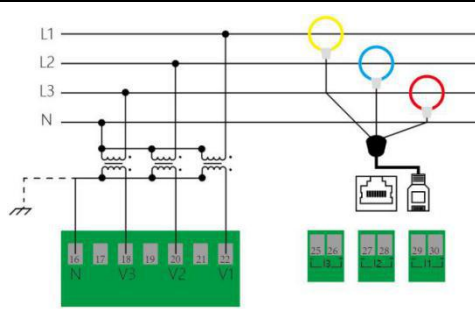

3PH4W(with PT) wiring diagram

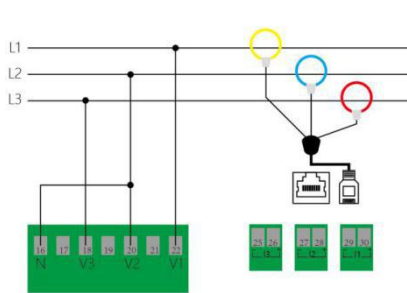

3PH3W(without PT) wiring diagram

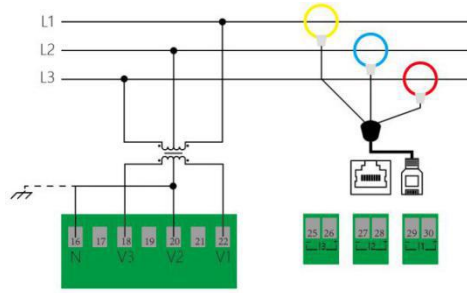

3PH3W(with PT) wiring diagram

4.3. RS485

The meter is equipped with a RS485 communication interface, which supports Modbus RTU protocol. The RS485 communication port requires shielded twisted pair connection, which is connected in the form of daisy chain. In the case of long distance and high speed, a 120 Ω resistor should be parallel connected at both ends of the daisy chain.

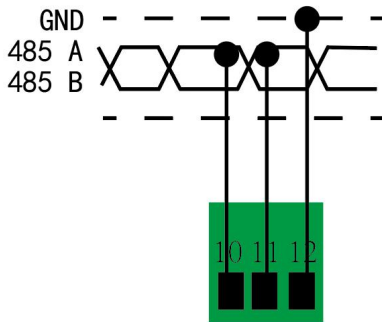

4.4. Relay output

The meter is equipped with a relay output and has two contacts, normally open and normally closed. The identification of terminal blocks is: R1, R0, R2, where R0 is the common contact, R1 is the normally open contact, and R2 is the normally closed contact. The relay output can be controlled by RS485 / Modbus protocol. RS485/ModBus

The protocol controls the closing and opening of the normally open contact. When the normally open contact is closed, the normally closed contact is opened; when the normally open contact is opened, the normally closed contact is closed. The closed state of normally open contact of relay is displayed on the display interface of electric meter. Maximum load capacity of relay: 3A 30V DC, 3A 250V AC

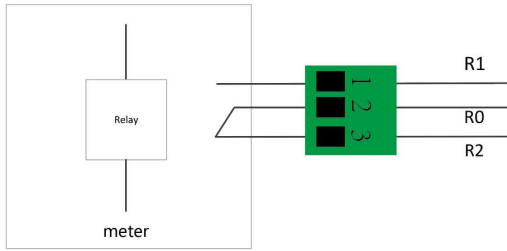

Relay output connection diagram

4.5. Digital output

The meter is equipped with two digital switch inputs, which are connected by passive dry contact. The identification of terminal blocks is: DI1, DI2, DIC, where DIC is the common contact. The status of two digital switch input can be read through RS485 / Modbus protocol, and the digital switch input status can be displayed in the electric meter display interface.

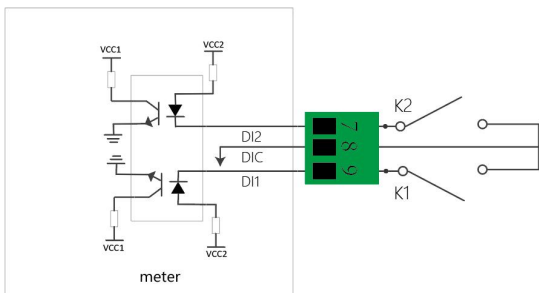

Digital input connection diagram

4.6. Electric energy pulse output

The meter is equipped with an active power pulse output, and the electric energy pulse constant EC can be viewed through the meter information interface. The internal optocoupler of the meter is isolated, the maximum allowable passing current is 80mA DC, and the working voltage range is 5V ~ 80V DC

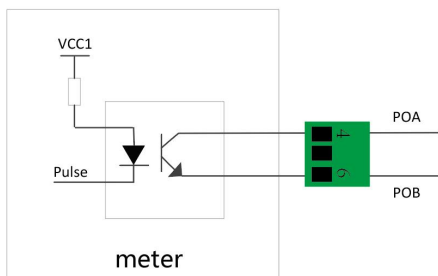

Energy pulse output connection diagram

5. Operation and interface display

This section is used to describe the display of the interface and key combination operation, as well as the configuration of the equipment.



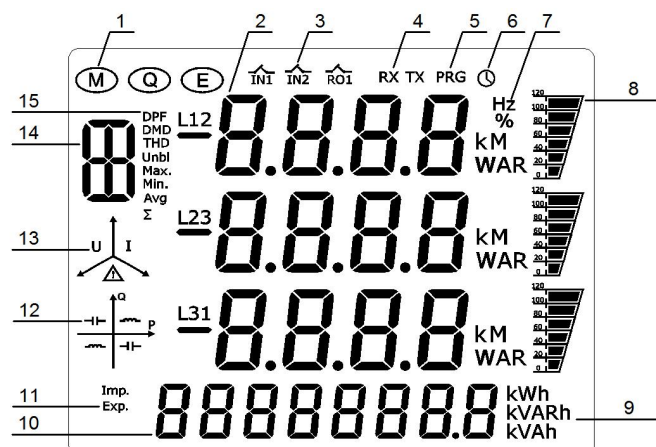

5.1. Display and key

The meter adopts LCD display and 4 control keys, and all display segment codes on the screen are shown in the following figure:

Description of interface symbol display



Number	Display symbols	Describe
1	(M) (Q) (E)	(M) : Indicates that the current interface is real-time measurement data display (Q) : Indicates that the current interface is power quality parameter display (E) : Indicates that the current interface is electric energy display
2	8	It is used to display various data
3	INI IN2 RO1	INI : Status display of digital input channel 1 IN2 : Status display of digital input channel 2 RO1 : Status display of relay output channel
4	RX TX	Communication status display, when there is data transmission, RX TX Will be displayed, otherwise no display will be displayed
5	PRG	Device configuration mode display, in which device parameters can be configured
6	⌚	Device information mode display, in which the device information can be viewed
7	Unit of measurement data	Voltage: V, KV, MV; Current: A, KA, MA; Active power: W, KW, MW Reactive power: VAR, KVAR, MVAR; Apparent power: VA, KVA, MVA Frequency: Hz, Percentage: %
8	Bar graph	Voltage, current, power percentage of the nominal value display
9	kWh kVARh kVAh	Electric energy unit display Active energy: kWh; Reactive energy: kVARh; Apparent energy: kVAh
10	8	Electric energy value display

11	Imp. Exp.	Positive and negative display of electric energy Forward power: imp.; reverse power: exp.
12		Power quadrant and load capacitive display
13		Voltage and current phase sequence display When the voltage phase sequence is not correct, Icon  It will flash When the current phase sequence is not correct, Icon  It will flash
14		Used to display data types: Voltage: U, electric current: I, Active power: P, Reactive power: Q, Apparent power: S
15	DPF DMD THD Unbl Max. Min. Avg Σ	Types of power quality parameters: power factor: PF, Fundamental power factor: DPF, Demand: DMD, Total harmonic: THD, Unbalance degree: Unbl, Maximum: Max., minimum value: Min., average value: Avg, Total: Σ

The four buttons of the meter are shown below



Return







Up



Down



Confirm

Key symbols	describe
	Return key: used to exit the current operation interface.
	Up key: used to switch the interface display and change the value size when setting.
	Down key: used to switch the interface display and change the value size when setting.
	Confirm key: used to confirm the operation and switch the numerical display when setting.

Key function display description:

5.2. Meter start interface

After the meter is powered on and started, the following interface will be displayed.

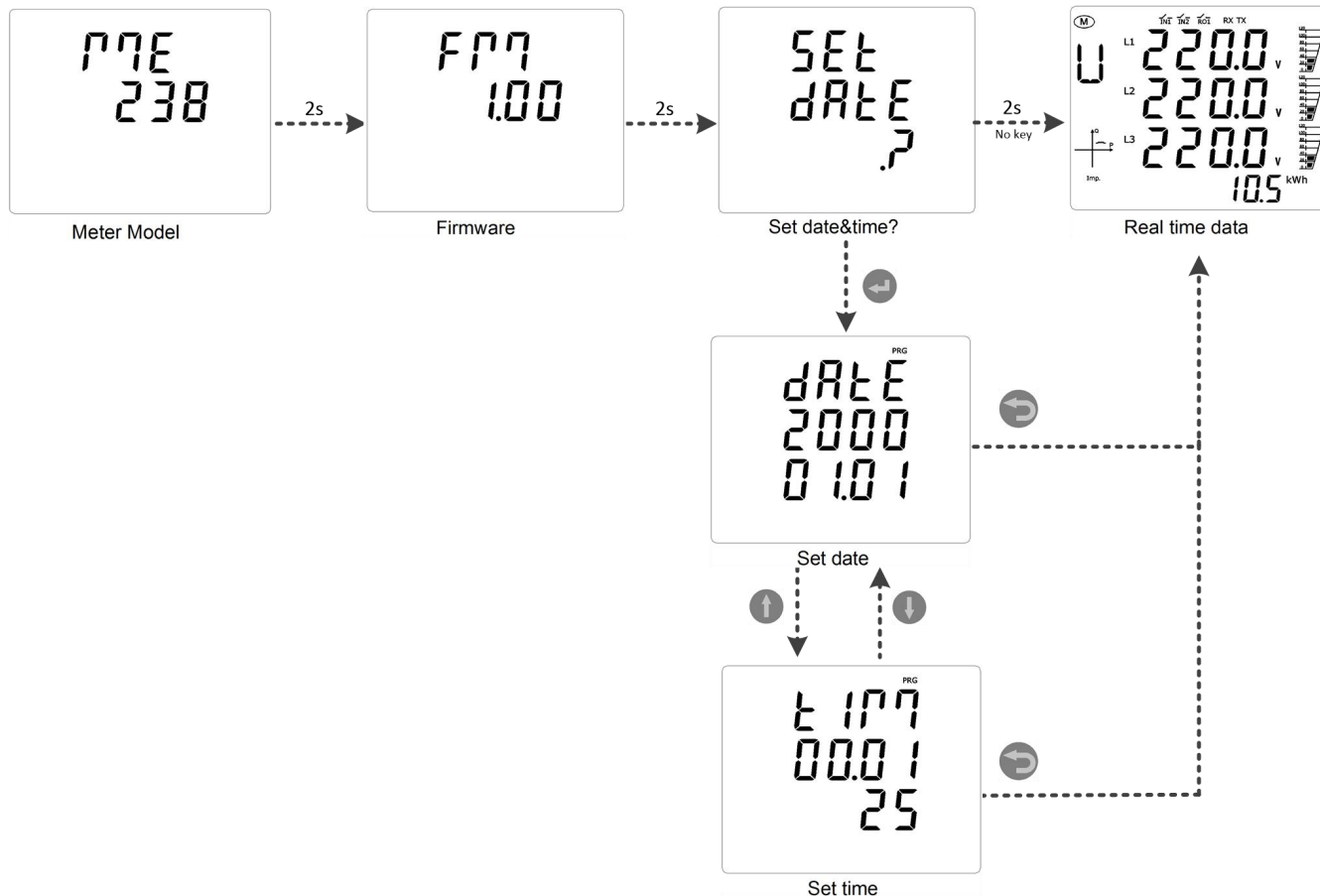

There is no backup battery for the meter clock. After the power failure and restart of the meter, the time will return to 00:00:00:00 on January 1, 2020. Therefore, it is necessary to set the time of the meter when starting, otherwise the time of the meter is not accurate.

5.3. Meter display mode switching

There are 5 real-time data display modes (M). Power quality display mode (Q). Power display mode (E). Device information display mode (⌚). Device configuration mode PRG; The switching between modes is shown in the figure below:

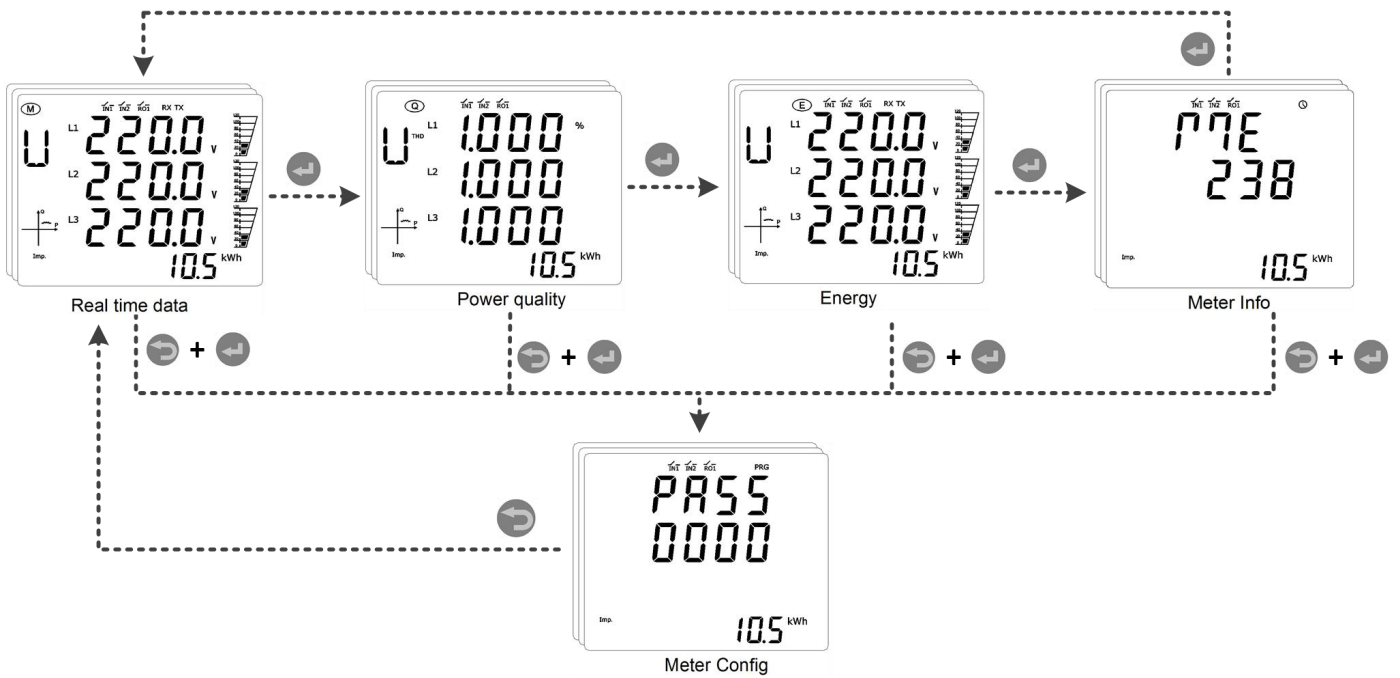

5.4. Real time measurement data display interface

Icon (M) display, Indicates that the current mode is the real-time measurement data mode, and the real-time measurement data display interface is used to display: voltage, current, power, power factor, frequency and other data. By pressing or , To switch the display of the interface.

In different wiring modes (three-phase four wire and three-phase three-wire), there will be different display interface.

The following figure shows the real-time measurement data display interface of ammeter under three-phase four wire system.

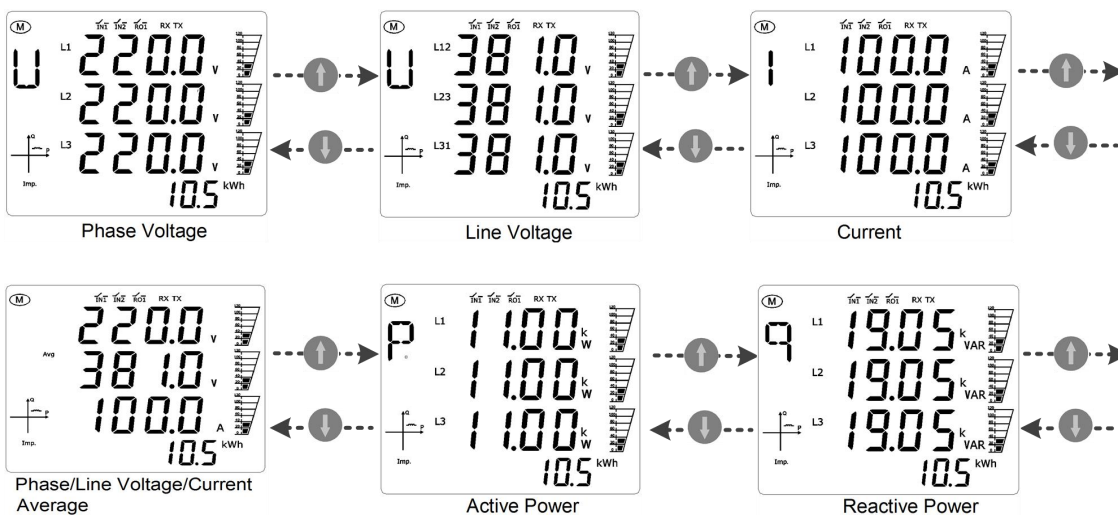

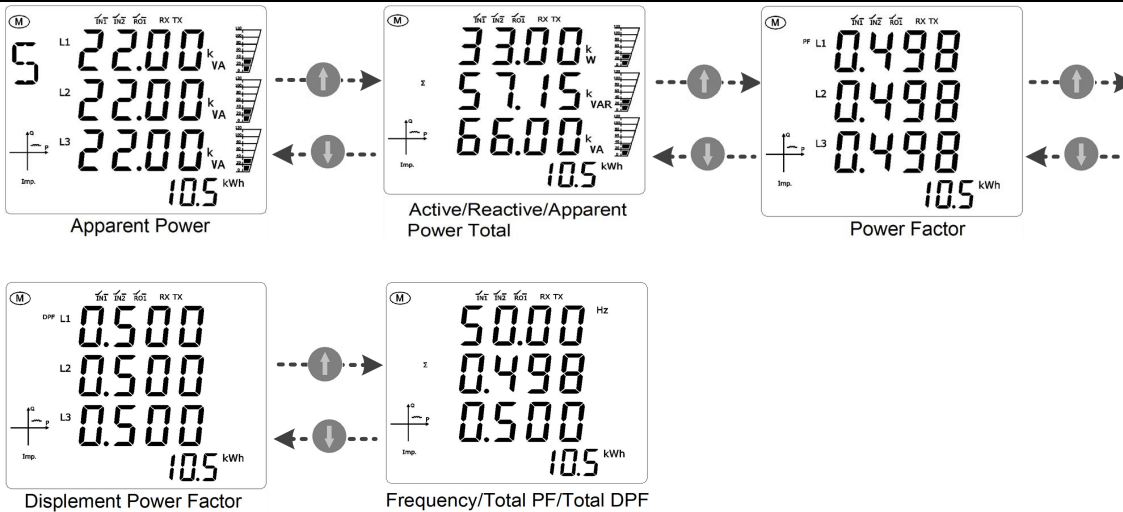

The following figure shows the real-time measurement data display interface of ammeter under three-phase three wire system.

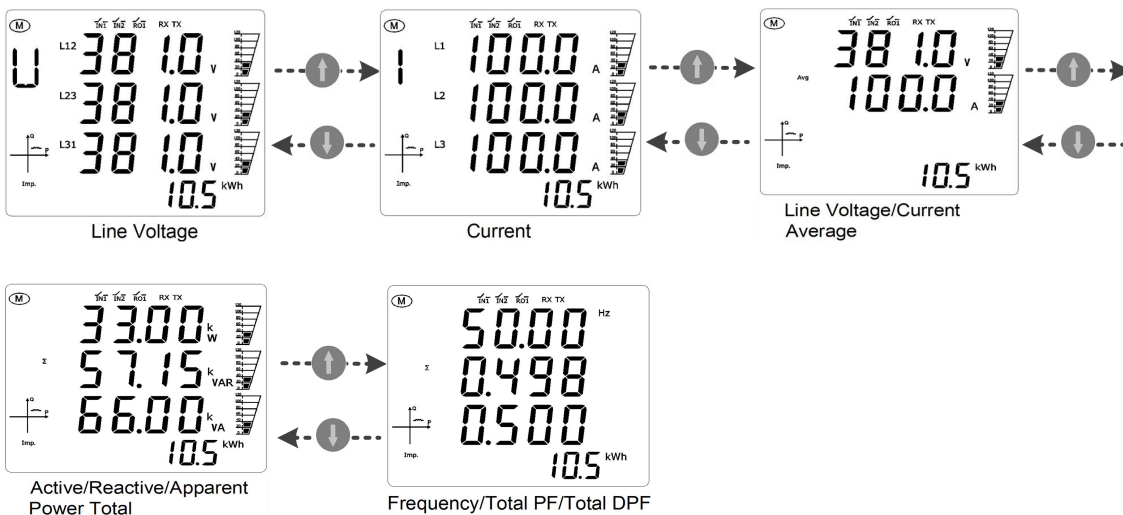

5.5. Power quality display interface

Icon display, Indicates that the current mode is current quality mode, The power quality display interface is used for display: Harmonics of voltage and current. Unbalance of voltage and current. Maximum and minimum voltage and current power. Current power demand and other data. By pressing or , To switch the display of the interface.

In different wiring modes (three-phase four wire and three-phase three-wire), there will be different display interface.

The following figure shows the power quality display interface of the meter under the three-phase four wire :

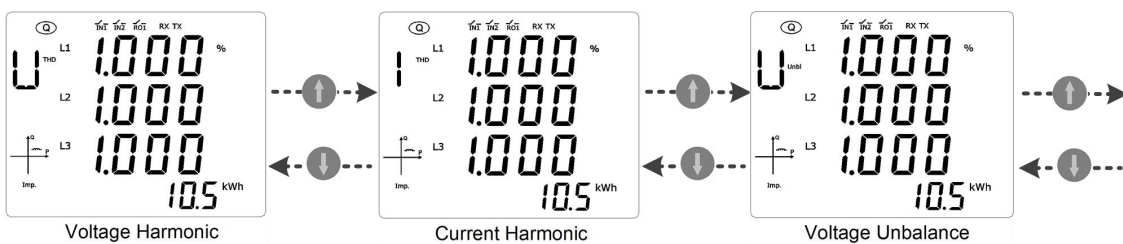

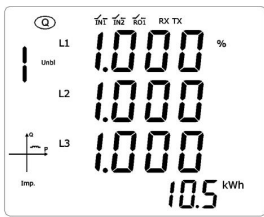

Current Unbalance

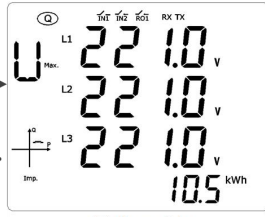

Voltage Max.

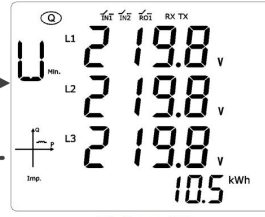

Voltage Min.

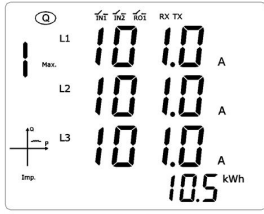

Current Max.

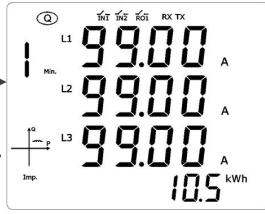

Current Min.

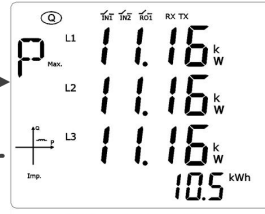

Active Power Max.

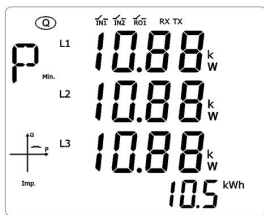

Active Power Min.

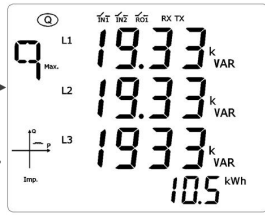

Reactive Power Max.

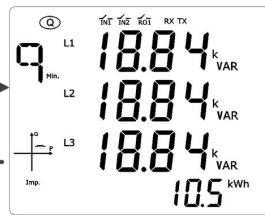

Reactive Power Min.

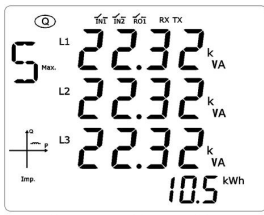

Apparent Power Max.

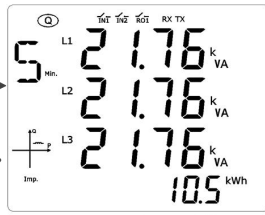

Apparent Power Min.

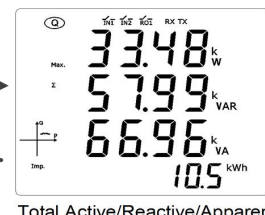

Total Active/Reactive/Apparent Power Max.

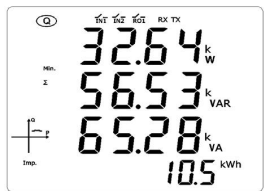

Total Active/Reactive/Apparent Power Min.



Current Demand

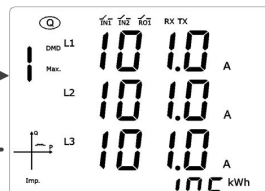

Current Demand Max.

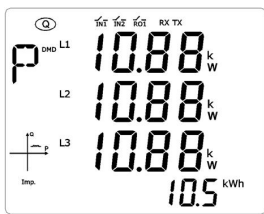

Active Power Demand

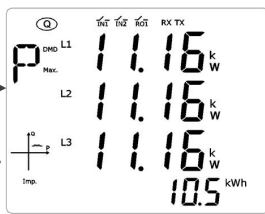

Active Power Demand Max.

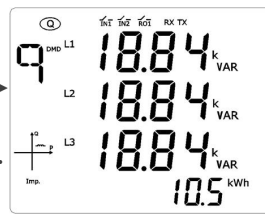

Reactive Power Demand

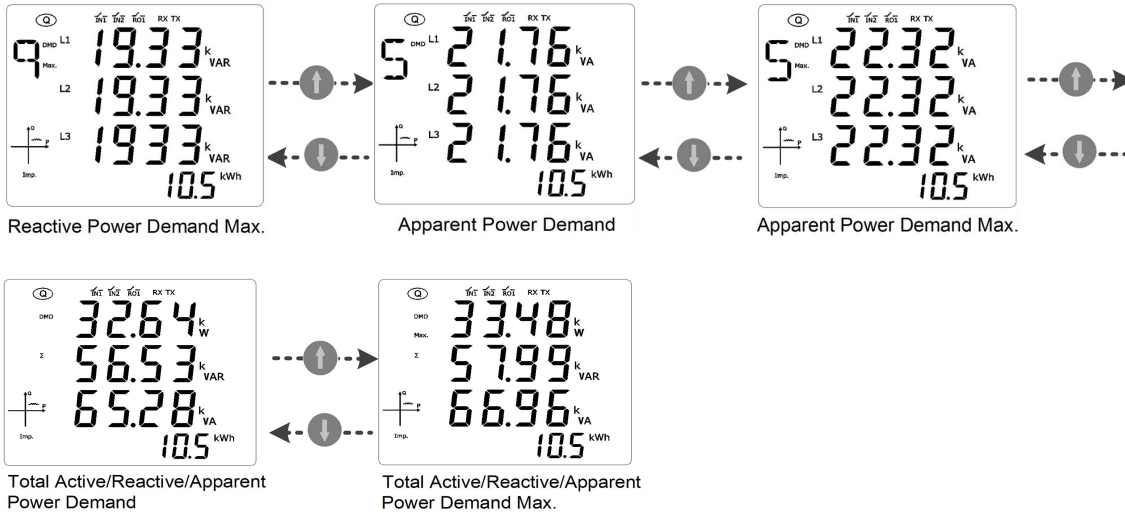

The following figure shows the power quality display interface of the meter under the three-phase three wire system.

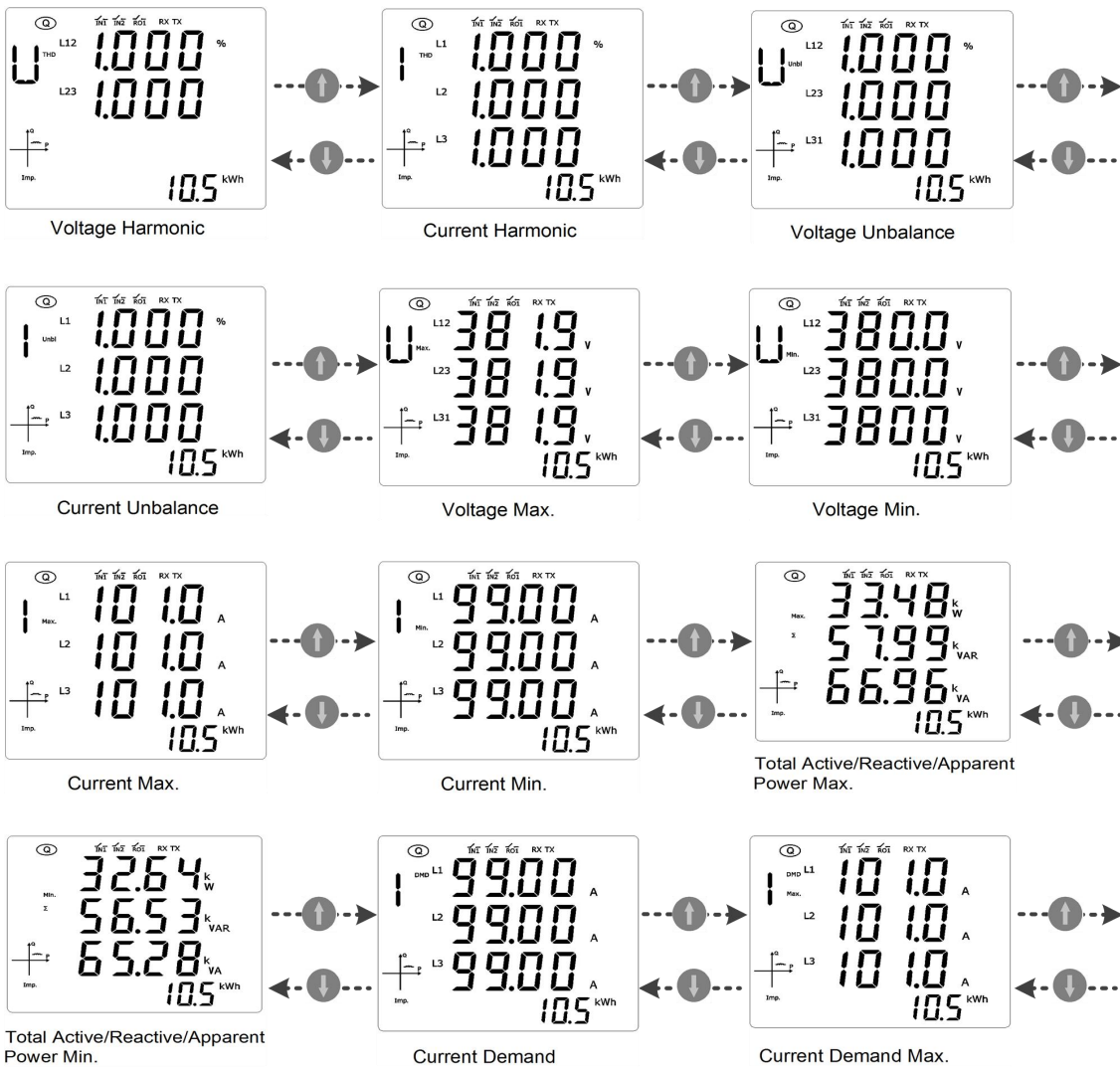

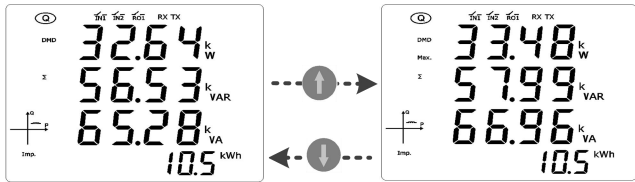

Total Active/Reactive/Apparent Power Demand

Total Active/Reactive/Apparent Power Demand Max.

5.6. Energy display interface

Icon **(E)** display, Indicates that the current mode is energy display mode, The energy display interface is used for display: Data of active energy, reactive energy and apparent energy. By pressing **(↑)** or **(↓)**, to switch the display of the interface.

In different wiring modes (three-phase four wire and three-phase three-wire), there will be different display interface.

The following figure shows the power quality display interface of the meter under the three-phase four wire :

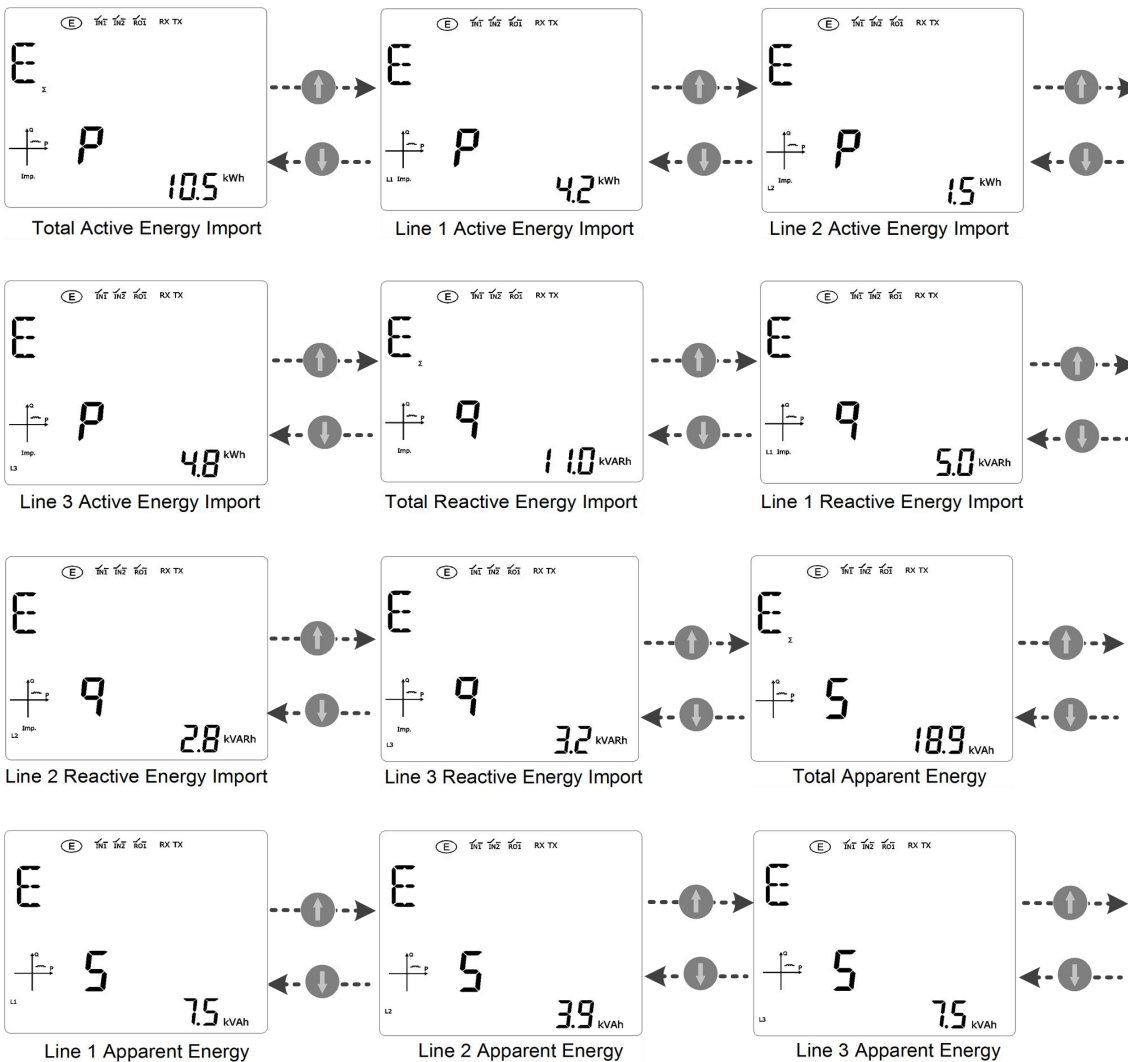

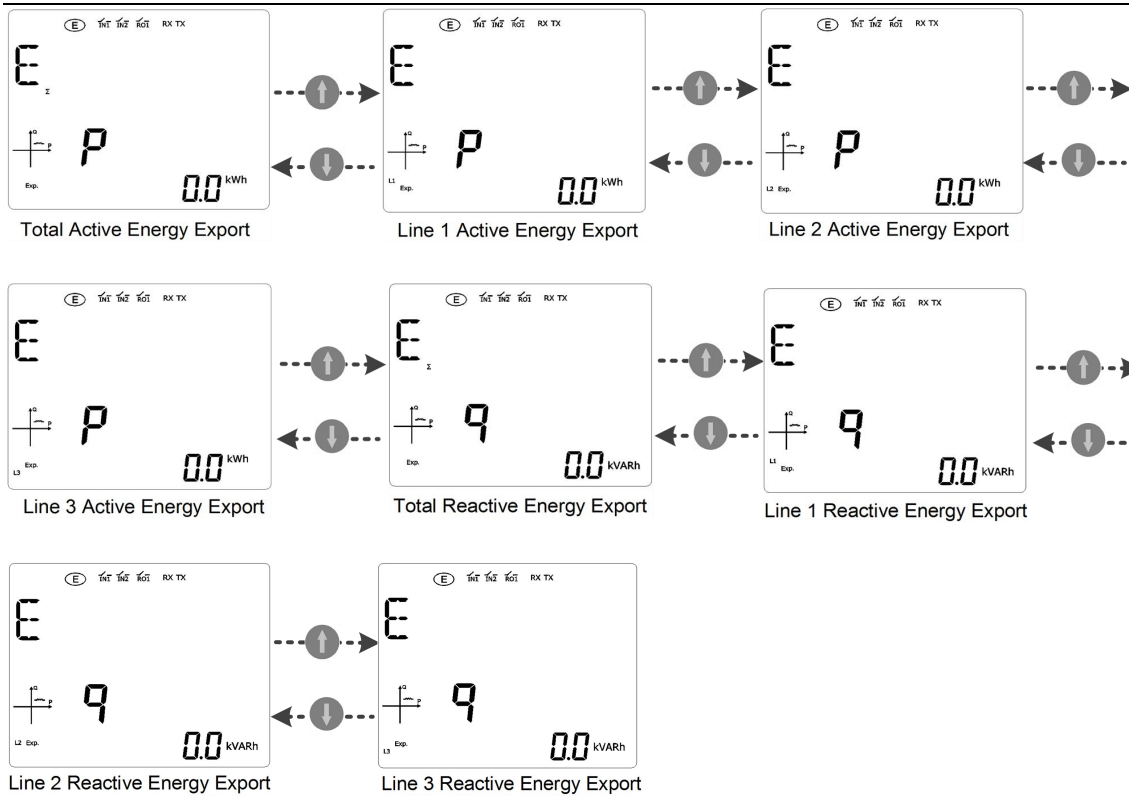

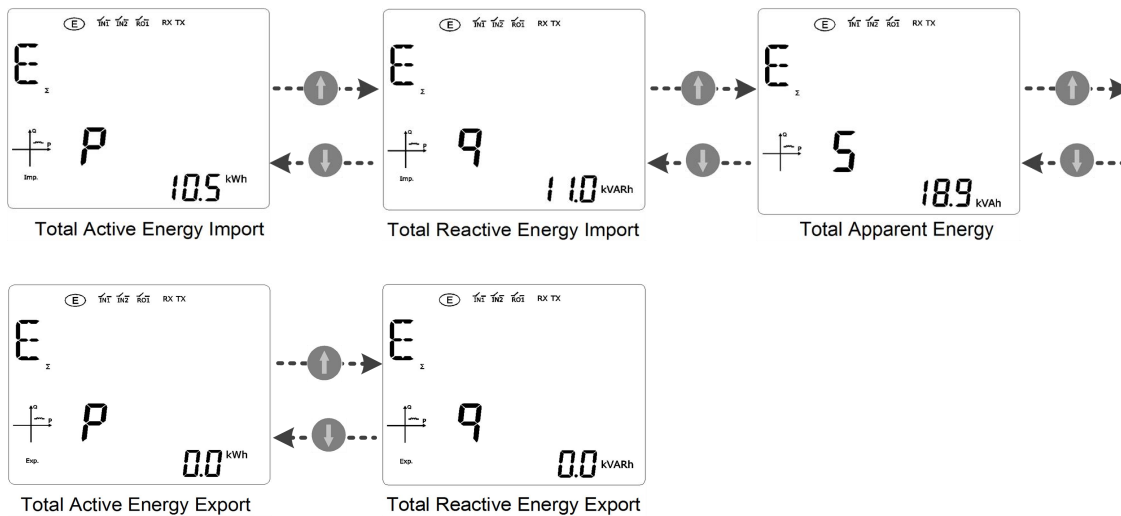

The following figure shows the power quality display interface of the meter under the three-phase three wire system.



5.7. Equipment information display interface

Icon  display, Indicates that the current mode is the device information display mode, The equipment information display interface is used to display: Equipment model.Firmware version.Communication parameters. energy constant.Equipment time and other data.By pressing  or , To switch the display of the interface.

The equipment information display interface is shown in the figure below:

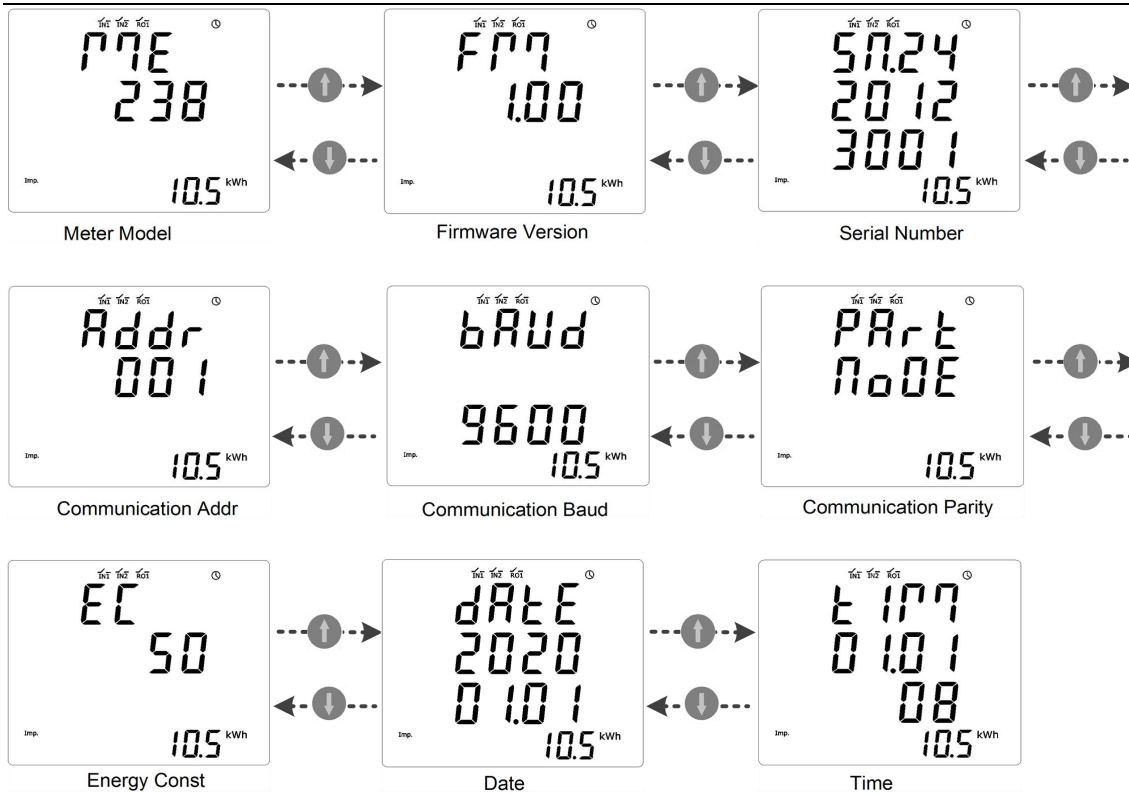

5.8. Equipment configuration display interface

Icon **PRG** display, Indicates that the current mode is device configuration mode, The device configuration interface is used for configuration: Wiring mode. Current sensor type and transformation ratio, voltage transformer transformation ratio, communication parameters, demand, backlight control, equipment time, clearing, password and other parameters. By pressing **↑** or **↓**, To switch the display of the interface, By pressing **←**, Enter parameter configuration.



Before enter the configuration page, you need to enter the configuration password (default 1000), By pressing **←** Enter password, By pressing **↑** or **↓**, Modify value size, By pressing **←** Toggles the value to be modified (the corresponding value will flash), if the password is correct, it will enter the configuration interface. If not, continue to stay in the password input interface.

➤ If you forget the configuration password, you can enter the last four digits of the device serial number to enter the configuration interface

The device configuration display interface is shown in the figure below:

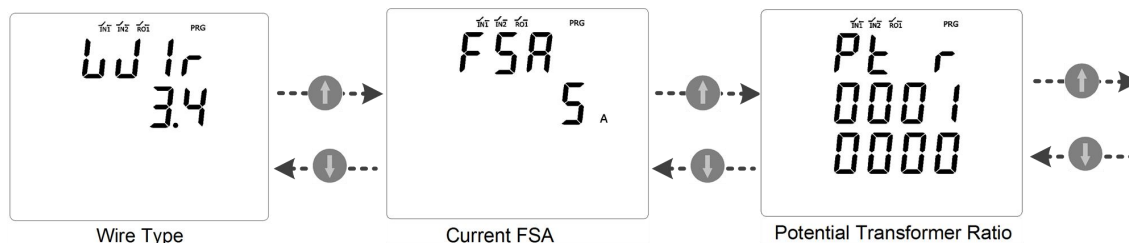

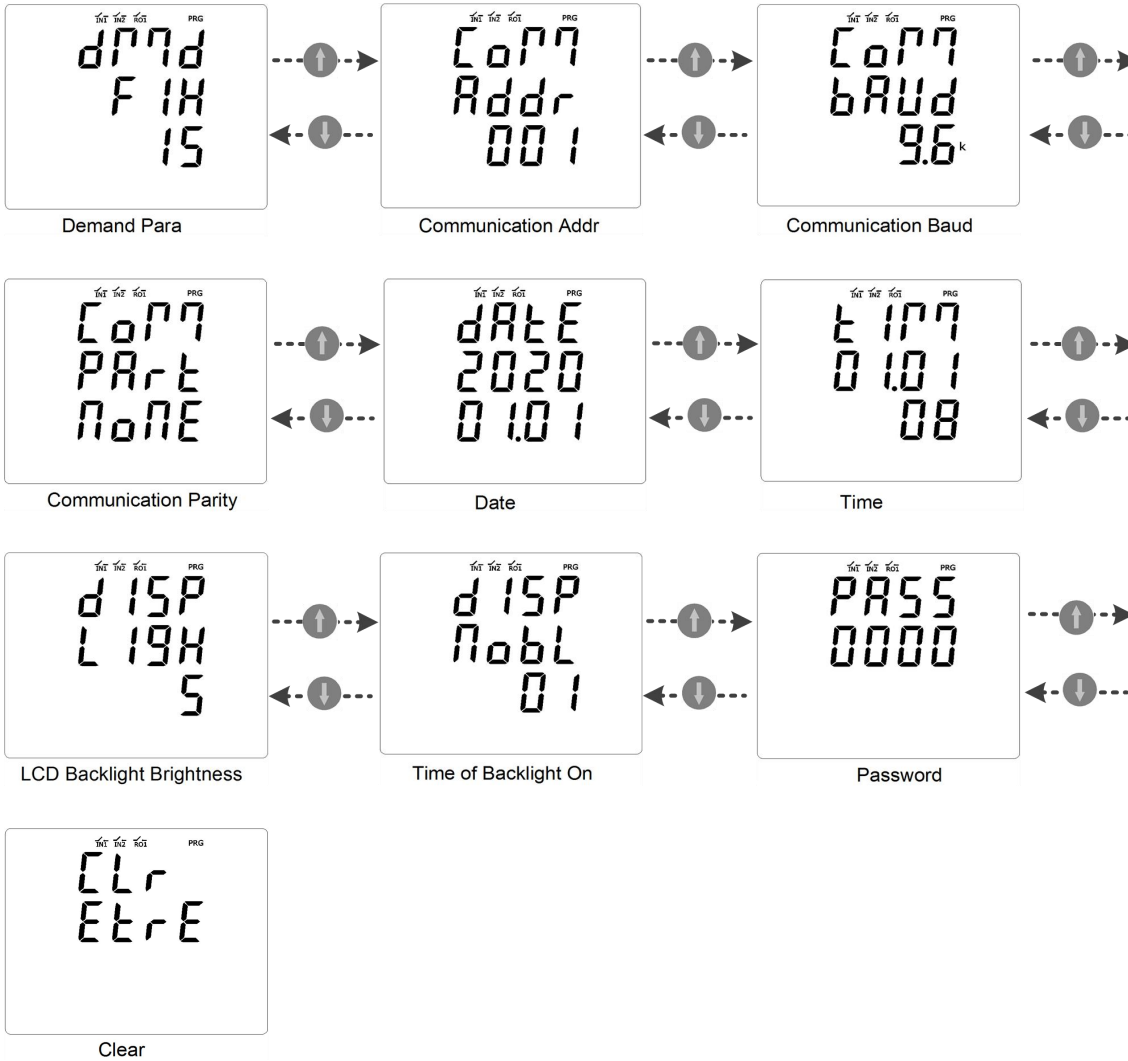

5.8.1. Configuration wiring mode

This page is used to configure the wiring mode of the equipment, which must be consistent with the actual wiring mode of the meter. The available wiring modes are:

- 3.4: Three phase four wire system
- 3.3: Three phase three wire system



Wire Type

Press the key to enter the setting, and the corresponding value will flash. Press or to modify the value, Press Toggles the value to be modify. After modifying the data, you will be prompted whether to save or not, press or , Select yes or no and press again to continue.



Save Wire Type

5.8.2. Current setting

This page is used to configure the current full scale as shown on the right, indicates the selection of current gear. The available current gears are as follows:

- 5A: The corresponding sensor model is STP-5
- 100A: The corresponding sensor model is STP-100
- 600A: The corresponding sensor model is STP-600
- 2500A: The corresponding sensor model is STP-2.5K
- 6000A: The corresponding sensor model is STP-6K

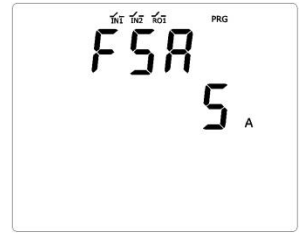

Current FSA

Press enter settings, the corresponding value will flash, Press or , modify values, Press toggles the value to be modified. After the data is modified, you will be prompted whether to save or not, Press or , to select Yes or no, Press perform the operation again.

5.8.3. Configure PT ratio

- This page is used to configure the transformation ratio of voltage transformer = (primary end voltage / secondary terminal voltage value) * 10000. Unit V / V.
- When there is no PT connection, the voltage value needs to be set to 10000.

Press enter settings, the corresponding value will flash, Press or , modify values, Press toggles the value to be modified. After the data is modified, you will be prompted whether to save or not,

Press or , To select Yes or no, press perform the operation again.



Potential Transformer Ratio

5.8.4. Calculation method of configuration demand

- This page is used to configure the calculation method and time of equipment demand. The configurable demand calculation methods are as follows:

- **FIH**: The demand is updated according to the set demand calculation time.
- **SL 1d**: The sliding type, the demand is updated every 1 minute, the demand calculation time can be set as 1 minute - 60 minutes, default value is 15 minutes.









Demand Para

Press enter settings, the corresponding value will flash, Press or , modify values, Press toggles the value to be modified. After the data is modified, you will be prompted whether to save or not, Press or , to select yes or no, press perform the operation again.

5.8.5. Configure communication address

- This page is used to configure the communication address of the device. When the communication address is used for RS485 communication, the device identification can be configured as 1-247:
- The default device address is 1.

Press  enter settings, the corresponding value will flash, Press  or , modify values, Press  toggles the value to be modified. After the data is modified, You will be prompted whether to save or not, Press  or  to select Yes or no, press  perform the operation again.



Communication Addr







5.8.6. Configure communication baud rate

This page is used to configure the device communication baud rate for RS485 communication:

- 2.4k: 2400bps
- 4.8k: 4800bps
- 9.6k: 9600bps
- 19.2k: 19200bps
- Default communication baud rate: 9600bps



Communication Baud

Press  enter settings, the corresponding value will flash, Press  or , modify values, Press  toggles the value to be modified. You will be prompted whether to save or not, Press  or , to select Yes or no, press  perform the operation again.







5.8.7. Configure communication parity

This page is used to configure the device communication parity, for RS485 communication, configurable:

- *none*: None
- *odd*: Odd
- *even*: Even
- Default communication parity: None



Communication Parity

Press  enter settings, the corresponding value will flash, Press  or , modify values, Press  toggles the value to be modified. You will be prompted whether to save or not, Press  or , to select Yes or no, press  perform the operation again.

5.8.8. Configure device clock date

This page is used to configure the date of the device clock. Since there is no backup battery for the meter clock, the date will be restored to 2020-01-01 after the meter is powered off and restarted. Therefore, the date needs to be reconfigured every time the meter is started.

Press enter settings, the corresponding value will flash, Press or , modify values, Press toggles the value to be modified. You will be prompted whether to save or not, Press or , to select Yes or no, press perform the operation again.



Date

5.8.9. Configure device clock time

This page is used to configure the time of the device clock. Since there is no backup battery for the meter clock, the time will be restored to 00:00:00 after power failure and restart of the meter. Therefore, the time needs to be reconfigured every time the meter is started.

Press enter settings, the corresponding value will flash, Press or , modify values, Press toggles the value to be modified. You will be prompted whether to save or not, Press or , to select Yes or no, press perform the operation again.



Time

5.8.10. Configure display backlight brightness

This page is used to configure the backlight brightness of the display screen. The backlight brightness of the display screen can be adjusted in 5 levels. The brightness of 1, 2, 3, 4, 5, 1 is the lowest and 5 is the highest

Press enter settings, the corresponding value will flash, Press or , modify values, Press toggles the value to be modified. You will be prompted whether to save or not, Press or , to select Yes or no, press perform the operation again.



LCD Backlight Brightness

5.8.11. Configure backlight off time setting

This page is used to configure the backlight off time. The backlight off time indicates how long the backlight is turned off without key operation. The setting time is 0-99 minutes

- Set it to 0 min, indicating that the backlight is always on, and the backlight is not turned off.
- If it is set to 1 minute, it means that the backlight will be turned off if there is no key operation in 1 minute. If the key is detected again, the backlight will be turned on.



Time of Backlight Off

Press enter settings, the corresponding value will flash, Press or , modify values, Press toggles the value to be modified. You will be prompted whether to save or not, Press or , to select Yes or no, press perform the operation again.

5.8.12. Configure device password

- This page is used to configure the device password, which is used to verify the authority when entering the configuration.
- Default password 1000

Press enter settings, the corresponding value will flash, Press or , modify values, Press toggles the value to be modified. You will be prompted whether to save or not, Press or , to select Yes or no, press perform the operation again.



Password

5.8.13. Clear

- This page is used to reset some measured parameters of the equipment. The parameter types that can be reset are as follows:

- **Et r E**: Clear Max and min
- **d r r d**: Clear demand
- **ENgy**: Clear energy
- **ALL**: Clear all (including maximum and minimum value, demand and energy)

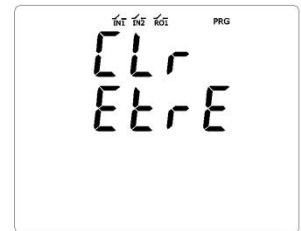

Clear

Press enter settings, the corresponding value will flash, Press or , modify values, Press toggles the value to be modified. You will be prompted whether to save or not, Press or , to select Yes or no, press perform the operation again.

6.Modbus Communication

ME238 adopts the standard Modbus RTU protocol, and the baud rate can be changed to 2400, 4800, 9600, 19200 by programming.

Modbus Communication settings

Modbus communication parameters are set as follows:

parameter	Effective value	Default value
Baud rate	-2400 -4800 -9600 -19200	9600
Parity check	– None – Odd – Even	None
Data bits	8	8
Stop bit	1	1
Address	1–247	1

Request instruction format

Slave address	Function code	Instruction data	CRC parity
8-Bits	8-Bits	N×8-Bits	16-Bits

Function code

The function code is used to tell the slave what to do. The following table lists the function codes supported by the device.

Function code		Function code name	description
decimal system	hexadecimal		
3	03H	Read register	Reading meter parameters
16	10H	Write multiple registers	Configure meter parameters

CRC verification method

The redundant cyclic code (CRC) contains two bytes, namely 16 bit binary. CRC code is calculated by the transmitting equipment and placed at the end of the sending message. The receiving equipment recalculates the CRC code of the received information, and compares whether the calculated CRC code is consistent with the received CRC code. If the two do not match, it indicates an error.

CRC code calculation method is to preset all 16 bit registers to 1. Each 8-bit data information is processed step by step. In CRC code calculation, only 8-bit data bits, start bits and stop bits are used. If there are parity check bits, parity check bits are included, which are not involved in CRC code calculation.

When the CRC code is calculated, the 8-bit data is different from the data in the register, and the result is moved to the low bit by one byte, and the highest bit is filled with 0. Check the lowest bit again. If the lowest bit is 1, the contents of the register are different from the preset or. If the lowest bit is 0, no XOR operation is performed.

This process is repeated eight times. After the 8th shift, the next 8 bits are different from the contents of the current register. Or, the process is repeated 8 times as above. When all the data information is processed, the content of the last register is CRC code value. In CRC code, the low byte is first when sending and receiving data.

The calculation steps of CRC code are as follows:

1. The preset 16 bit register is hexadecimal ffff (i.e. all are 1), which is called CRC register.
2. The first 8-bit data is different from the low order of 16 bit CRC register or, and the result is put in CRC register.
3. Move the contents of the register to the right (toward the low position), fill the highest bit with 0, and check the lowest bit.
4. If the lowest bit is 0: repeat step 3 (shift again);

If the lowest bit is 1: CRC register XOR polynomial A001 (101000000000 0001).

5. Repeat steps 3 and 4 until moving right 8 times, so that all 8-bit data are processed.
6. Repeat steps 2 to 5 to process the next 8-bit data.
7. The final CRC register is CRC code

Register list

The register list has the following entries:

Register name	Register address	operation Read / write	register number	type	Unit	description
---------------	------------------	---------------------------	--------------------	------	------	-------------

•Register name: used to indicate the purpose of the register.

•Register address: the address of Modbus register in decimal system.

• Operation: used to indicate the operation that the register can perform.

• Number of registers: indicates how many int16 sizes the register has.

• Type: describes the type of data

• Unit: indicates the size of the register value unit

• Description: a description of the register

Data type list

The following table lists the data types used in this document:

Type	description	Range
UInt16	16 bit unsigned integer	0–65535
Int16	16 bit signed integer	-32768–+32767
UInt32	32-bit unsigned integer	0–4 294 967 295
UInt64	64 bit unsigned integer	0–18 446 744 073 709 551 615
UTF8	8-bit UTF	Multibyte unicode coding
Float32	32-bit floating point number	Standard IEEE single precision floating point numbers
Bitmap	–	–
Date Time	–	-

Data format:

16bit 序号	unit															
	15	14	13	12	11	10	9	8	7	6	5	4	3	2	1	0
1	retain (0)								year (0–99, Since 2000)							
2	month (1–12)								day (1–31)							
3	Hour (0–23)								second (0–59)							
4	millisecond (0–59999)															

About the definition of data byte direction:

Except for the CRC-16 check code at the end of the instruction, the receiving and sending byte order of all other data is high byte first.

Function code (3) operation instructions

Function code 3 is used to read device configuration parameters, and its request and return instructions are defined as follows:

Read device parameter instruction format:

Serial number	Significance	Type	Range	description
1	Device address	UInt8	1-247	
2	Function code	UInt8	3	
3	Register start address	UInt16	-	High byte first

4	Number of read registers	UInt16	1-127	High byte first
5	CRC-16 parity code	UInt16	-	Low byte first

Return device parameter command format:

Serial number	Significance	Type	Range	description
1	Device address	UInt8	1-247	
2	Function code	UInt8	3	
3	Data byte length	UInt8	-	Number of registers * 2
4	1st register data	UInt16	-	High byte first
5	...	UInt16	-	High byte first
6	nth register data	UInt16	-	High byte first
7	CRC-16 parity code	UInt16	-	Low byte first

Example of reading device parameters:

Read the voltage values of phase A, phase B and phase C of the meter (starting from address 2147)

Serial number	Significance	Type	Value (decimal)	Value (HEX)	description
1	Device address	UInt8	1	01	
2	Function code	UInt8	3	03	
3	Register start address	UInt16	1000	03E8	Starting address of phase A voltage
4	Number of read registers	UInt16	6	0006	The voltage of phase A, phase B and phase C occupy two registers respectively
5	CRC-16 parity code	UInt16	47173	B845	

The order of sending hexadecimal bytes is as follows:

01 03 03 E8 00 06 45 B8

The received packets are as follows:

01 03 0C 43 5C 00 00 43 5C 00 00 43 5C 00 00 A5 AC

Analysis:

Serial number	Significance	Type	Value(HEX)	Value (decimal)
1	Device address	UInt8	01	1
2	Function code	UInt8	03	3
3	Data byte length	UInt8	0C	12
4	Address 2147 data (phase a voltage)	Float32	435C0000	220
5	Address 2148 data (phase B voltage)	Float32	435C0000	220
6	Address 2149 data (phase C voltage)	Float32	435C0000	220
7	CRC-16 parity code	UInt16	ACA5	

Function code (16) operation instructions

Function code 16 is used to configure the parameters of the device, and its request and return instructions are defined as follows:

Configuration device parameter command format:

Serial number	Significance	Type	Range	Description
1	Device address	UInt8	1-247	
2	Function code	UInt8	16	
3	Register start address	UInt16	-	High byte first
4	Number of configuration registers	UInt16	1-127	High byte first
5	Data length	UInt8		Number of configuration registers * 2
6	First register configuration data	UInt16	-	High byte first
7	...	UInt16	-	High byte first
8	nth register configuration data	UInt16	-	High byte first
9	CRC-16 parity code	UInt16	-	low byte first

Return to configuration device parameter command format:

Serial number	Significance	Type	Range	Description
1	Device address	UInt8	1-247	
2	Function code	UInt8	16	
3	Register start address	UInt16	-	High byte first
4	Number of configuration registers	UInt16	1-127	High byte first

5	CRC-16 parity code	UInt16	-	low byte first
---	--------------------	--------	---	----------------

The device parameter configuration can only be configured by writing the corresponding data to the "device parameter configuration register", that is, writing the corresponding data to the address starting from 300 to configure the corresponding parameters.

Meter configuration:

You can configure the meter through RS485 / modbus, and write the corresponding instruction code and parameters to the instruction register (starting from address 300) with function code 16.

Configuration request:

The following table lists the common packet formats for meter configuration:

Slave address	Function code	Instruction register address	Number of instruction registers	data length	Write the value of instruction registe	CRC parity
1-247	16	300 (maximum 423)	N	N×2		

Configuration results:

The configuration results can be obtained by reading registers 424 and 425.

Register address	Description	Size (UInt16)	Data (example)
424	Configuration instruction code	1	1001(set Date Time)
425	Configuration results	1	0 = configuration successful 80 = invalid instruction code 81 = invalid parameter value 82 = number of invalid parameters 83 = instruction not executed

Configuration request example:

The following table lists the data packages for configuring meter time:

The time of the meter will be set at 5:56:55 in 2018:

Serial number	Significance	Type	Value (decimal)	Value (HEX)	description
1	Device address	UInt8	1	01	
2	Function code	UInt8	16	10	
3	Data byte length	UInt16	300	012C	Configuration register start address
4	Number of read registers	UInt16	7	0007	Configure Time Command + parameter total 7 registers are occupied
5	Data length	UInt8	14	0E	Number of configuration registers * 2
6	Register 300 write value	UInt16	1001	03E9	Instruction code 1001 to configure time
7	Register 301 write value	UInt16	2018	07E2	Year of configuration time = 2018
8	Register 302 write value	UInt16	5	0005	Month of configuration time = 5
9	Register 303 write value	UInt16	9	0009	Day of configuration time = 9
10	Register 304 write value	UInt16	13	000D	Time of configuration = 13
11	Register 305 write value	UInt16	56	0038	Minutes of configuration time = 56
12	Register 306 write value	UInt16	55	0037	Seconds of configuration time = 55
13	CRC-16 parity code	UInt16	46647	9B72	

The order of sending bytes is as follows:

01 10 01 2C 00 07 0E 03 E9 07 E2 00 05 00 09 00 0D 00 38 00 37 72 9B

After the configuration is successful, the received data packets are as follows:

01 10 01 2C 00 07 41 FE

分析:

Serial number	Significance	Type	Value (decimal)	Value (HEX)
1	Device address	UInt8	01	1
2	Function code	UInt8	10	16
3	Register start address	UInt16	012C	300
4	Number of configuration registers	UInt16	0007	7
5	CRC-16 parity code	UInt16	FE41	

Note: all reserved parameter values should be set to 0.

Error return instruction description:

When it is not the above instruction or instruction parameter error, the device will return a piece of data to explain the cause of the error. The data format is as follows:

Device address (UInt8)	Function code (UInt8)	Error code (UInt8)	CRC-16 (UInt16)
1	Request function code + 0x80	The codes are shown in the table below	

Error code	Significance
1	The function code is not supported
2	Invalid data address
3	The data value does not meet the requirements
4	Data read / write error

Configuration instruction list

Set system time

Instruction code	operation	size	Type	Unit	Range	Description
1001	W	1	UInt16	-	2000-2099	Year
	W	1	UInt16	-	1-12	Month
	W	1	UInt16	-	1-31	Day
	W	1	UInt16	-	0-23	Hour
	W	1	UInt16	-	0-59	Minute
	W	1	UInt16	-	0-59	Second

Set communication parameters

Instruction code	operation	size	Type	Unit	Range	Description
1002	W	1	UInt16	-	1-247	Slave address
	W	1	UInt16	-	0, 1, 2, 3	Baud rate 0=2400 1=4800 2=9600 3=19200
	W	R/WC	UInt16	-	0, 1, 2	Parity 0 = None 1 = Odd 2 = Even

Setting grid parameters

Instruction code	operation	Size	Type	Unit	Range	Description	Remarks
1003	W	1	UInt16	-	0, 1	Wiring mode 0 = 3PH4W 1 = 3PH3W	
	W	2	UInt32	V/V	1-99999999	PT ratio *10000	
	W	1	UInt16	-	0, 1, 2,3,4	Nominal current 0=5A 1=100A 2=600A 3=2500A 4=6000A	

Set relay output

Instruction code	operation	Size	Type	Unit	Range	Description
1005	W	1	UInt16	-	0-1	0 = relay output open circuit 1 = relay output closed

Set demand

Instruction code	operation	Size	Type	Unit	Range	Description
1006	W	1	UInt16	-	0, 1	Calculation method of demand

						0 = fixed 1 = sliding
	W	1	UInt16	minute	1-60	Demand interval

Clearing energy

Instruction code	operation	Size	Type	Unit	Range	Description
2000	W	1	UInt16	-	2000	Clear energy

The minimum and the maximum value of reset

Instruction code	operation	Size	Type	Unit	Range	Description
2001	W	1	UInt16	-	2001	2001: reset max and min

The maximum demand of reset

Instruction code	operation	Size	Type	Unit	Range	Description
2002	W	1	UInt16	-	2002	2002: The maximum demand of reset.

Modbus Register list

Register name	Register address	operation	Size	Type	Unit	Description
Meter model	50	R	20	UTF8	-	
Serial number	70	R	2	UInt32	-	
Firmware Version	72	R	1	UInt16	-	The data format is: X.Y.ZTT
Date & time	73	R/WC	4	Date time	-	Register 73: year 00-99 (from 2000 to 2099) Register 74: month (B15: B8), day (B7: B0) Register 75: hour (B15: B8), minute (B7: B0) Register 76: ms

Communication parameters

Register name	Register address	operation	Size	Type	Unit	Description
Slave address	80	R/WC	1	UInt16	-	1-247
Baud rate	81	R/WC	1	UInt16	-	0=2400

						1=4800 2=9600 3=19200
Parity	82	R/WC	1	UInt16	-	0 = None 1 = Odd 2 = Even

Power parameter

Register name	Register address	Operation	Size	Type	Unit	Description
Wiring mode	90	R/WC	1	UInt16	-	0 = 3PH4W 1 = 3PH3W
PT ratio	91	R/WC	2	UInt32	V/V	PT ratio*10000
Nominal current	93	R/WC	1	UInt16	-	0=5A 1=100A 2=600A 3=2500A 4=6000A

Relay output

Register name	Register address	Operation	Size	Type	Unit	Description
Relay output status	150	R/WC	1	UInt16	-	0 = relay output open circuit 1 = relay output closed

Digital input

Register name	Register address	Operation	Size	Type	Unit	Description
Relay output status	151	R	1	UInt16	-	0 = D11 open, D12 open 1 = D11 closed, D12 open 2 = D11 open, D12 closed 3 = D11 closed, D12 closed

Voltage and current phase sequence

Register name	Register address	Operation	Size	Type	Unit	Description
Voltage current phase sequence state	152	R	1	UInt16	-	0 = voltage sequence is correct, current sequence is correct 1 = voltage sequence wrong, current sequence correct 2 = voltage sequence correct, current sequence wrong 3 = voltage sequence wrong, current sequence wrong

Note: when the current is small, the current phase sequence may display error

Configure instruction register list

Register name	Register address	Operation	Size	Type	Unit	Description
Instruction code	300	R/W	1	UInt16	-	
Instruction parameters 001	301	R/W	1	UInt16	-	

Instruction parameters 002	302	R/W	1	UInt16	-	
...	...	R/W	1	UInt16	-	
Instruction parameters 123	423	R/W	1	UInt16	-	
Configuration instruction code	424	R	1	UInt16	-	
Configuration operation status	425	R	1	UInt16	-	0 = valid configuration 80 = invalid instruction code 81 = invalid instruction parameter value. 82 = number of invalid instruction parameters. 83 = instruction not executed.

Basic data

Current, voltage, power, power factor, frequency

Register name	register address	operation	Size	Type	Unit	Description
Phase voltage						
U1	1000	R	2	Float32	V	Voltage value of phase A
U2	1002	R	2	Float32	V	Voltage value of phase B
U3	1004	R	2	Float32	V	Voltage value of phase C
Voltage Avg	1006	R	2	Float32	V	Average phase voltage value
Line voltage						
U12	1008	R	2	Float32	V	Voltage value of line A-B
U23	1010	R	2	Float32	V	Voltage value of line B-C
U31	1012	R	2	Float32	V	Voltage value of line C-A
Voltage Avg	1014	R	2	Float32	V	Average line voltage value
Current						
I1	1016	R	2	Float32	A	Current value of phase A
I2	1018	R	2	Float32	A	Current value of phase B
I3	1020	R	2	Float32	A	Current value of phase C
Current Avg	1022	R	2	Float32	A	Average value of three-phase current
Power						

P1	1026	R	2	Float32	W	Active power of phase A
P2	1028	R	2	Float32	W	Active power of phase B
P3	1030	R	2	Float32	W	Active power of phase C
PTotal	1032	R	2	Float32	W	Sum of three-phase active power
Q1	1034	R	2	Float32	Var	Reactive power of phase A
Q2	1036	R	2	Float32	Var	Reactive power of phase B
Q3	1038	R	2	Float32	Var	Reactive power of phase C
QTotal	1040	R	2	Float32	Var	Sum of three-phase reactive power
S1	1042	R	2	Float32	Va	Apparent power of phase A
S2	1044	R	2	Float32	Va	Apparent power of phase B
S3	1046	R	2	Float32	Va	Apparent power of phase A
STotal	1048	R	2	Float32	Va	Sum of three-phase apparent power
power factor						
PF1	1050	R	2	Float32	-	Power factor of phase A
PF2	1052	R	2	Float32	-	Power factor of phase B
PF3	1054	R	2	Float32	-	Power factor of phase C
PF Avg	1056	R	2	Float32	-	Average power factor
DPF1	1058	R	2	Float32	-	Fundamental power factor of phase A
DPF2	1060	R	2	Float32	-	Fundamental power factor of phase B
DPF3	1062	R	2	Float32	-	Fundamental power factor of phase C
DPF Avg	1064	R	2	Float32	-	Average fundamental power factor
Frequency						
Freq	1066	R	2	Float32	Hz	Grid frequency

Harmonic

Register name	register address	operation	Size	Type	Unit	Description
Voltage harmonic						
U1THD	2000	R	2	Float32	%	Percentage of total harmonic of voltage of phase A.
U2THD	2002	R	2	Float32	%	Percentage of total harmonic of voltage of phase B
U3THD	2004	R	2	Float32	%	Percentage of total harmonic of voltage of phase A.
UTHD Avg	2006	R	2	Float32	%	Three phase voltage total harmonic percentage average.

Current harmonic						
I1THD	2008	R	2	Float32	%	Percentage of total harmonic current of phase A.
I2THD	2010	R	2	Float32	%	Percentage of total harmonic current of phase B.
I3THD	2012	R	2	Float32	%	Percentage of total harmonic current of phase C.
ITHD Avg	2014	R	2	Float32	%	Percentage average value of total harmonic of three-phase current.

Energy

When the total electric energy reaches 999999.9kwh, 999999.9kvarh or 999999.9kvah, the electric energy of each phase will be cleared automatically.

Register name	register address	operation	Size	Type	Unit	Description
Active energy						
EP1Imp	4000	R	2	UInt32	0.1kWh	Positive active energy of Phase A
EP2Imp	4002	R	2	UInt32	0.1kWh	Positive active energy of Phase B
EP3Imp	4004	R	2	UInt32	0.1kWh	Positive active energy of Phase C
EPImp	4006	R	2	UInt32	0.1kWh	Sum of three-phase positive active energy.
EP1Exp	4008	R	2	UInt32	0.1kWh	Reverse active electric energy of Phase A.
EP2Exp	4010	R	2	UInt32	0.1kWh	Reverse active electric energy of Phase B.
EP3Exp	4012	R	2	UInt32	0.1kWh	Reverse active electric energy of Phase C.
EPExp	4014	R	2	UInt32	0.1kWh	Sum of three-phase reverse active energy.
Reactive energy						
EQ1Imp	4024	R	2	UInt32	0.1kVarh	Positive reactive energy of Phase A.
EQ2Imp	4026	R	2	UInt32	0.1kVarh	Positive reactive energy of Phase B.
EQ3Imp	4028	R	2	UInt32	0.1kVarh	Positive reactive energy of Phase C.
EQImp	4030	R	2	UInt32	0.1kVarh	Sum of three-phase positive reactive energy.
EQ1Exp	4032	R	2	UInt32	0.1kVarh	Reverse reactive energy of Phase A.
EQ2Exp	4034	R	2	UInt32	0.1kVarh	Reverse reactive energy of Phase B.
EQ3Exp	4036	R	2	UInt32	0.1kVarh	Reverse reactive energy of Phase C.
EQExp	4038	R	2	UInt32	0.1kVarh	Sum of three-phase reverse reactive energy.
Apparent energy						
ES1	4048	R	2	UInt32	0.1kVah	Apparent energy of Phase A.
ES2	4050	R	2	UInt32	0.1kVah	Apparent energy of Phase B.
ES3	4052	R	2	UInt32	0.1kVah	Apparent energy of Phase C.
ES	4054	R	2	UInt32	0.1kVah	Sum of three-phase apparent energy.

Demand

Register alias	Register Starting address (decimal)	operation Read / write	Size	Type	Unit	Description
Basic parameters of demand						
DMDMethod	5000	R/WC	1	UInt16	-	Calculation method of demand: 0 = sliding 1 = fixed
DMDInterVal	5001	R/RC	1	UInt16	minute	Demand interval
PDMD Reset Time	5002	R	4	Date time	-	Reset date and time of maximum demand
Power demand						
P1Demand	5020	R	2	Float32	W	Active power demand of phase A
P1PeakDemand	5022	R	2	Float32	W	Maximum active power demand of phase A
P1PeakDemandDate	5024	R	4	Date time	-	Occurrence time of maximum active power demand of phase A.
P2Demand	5028	R	2	Float32	W	Current active power demand of phase B
P2PeakDemand	5030	R	2	Float32	W	Maximum active power demand of phase B
P2PeakDemandDate	5032	R	4	Date time	-	Occurrence time of maximum active power demand of phase B.
P3Demand	5036	R	2	Float32	W	Current active power demand of phase A.
P3PeakDemand	5038	R	2	Float32	W	Maximum active power demand of phase B.
P3PeakDemandDate	5040	R	4	Date time	-	Occurrence time of maximum active power demand of phase B.
PSUMDemand	5044	R	2	Float32	W	Current total active power demand
PSUMPeakDemand	5046	R	2	Float32	W	Maximum demand of total active power
PSUMPeakDemand Date	5048	R	4	Date time	-	Occurrence time of maximum demand of total active power
Q1Demand	5052	R	2	Float32	Var	Current reactive power demand of Phase A.
Q1PeakDemand	5054	R	2	Float32	Var	Maximum reactive power demand of phase A.
Q1PeakDemandDate	5056	R	4	Date time	-	Maximum reactive power demand time of phase A.

Q2Demand	5060	R	2	Float32	Var	Current reactive power demand of phase B.
Q2PeakDemand	5062	R	2	Float32	Var	Maximum reactive power demand of phase B.
Q2PeakDemandDate	5064	R	4	Date time	-	Maximum reactive power demand time of phase B.
Q3Demand	5068	R	2	Float32	Var	Current reactive power demand of Phase C.
Q3PeakDemand	5070	R	2	Float32	Var	Maximum reactive power demand of phase C.
Q3PeakDemandDate	5072	R	4	Date time	-	Maximum reactive power demand time of phase C.
QSUMDemand	5076	R	2	Float32	Var	Occurrence time of maximum active power demand of phase B.
QSUMPeakDemand	5078	R	2	Float32	Var	Current total active power demand
QSUMPeakDemand Date	5080	R	4	Date time	-	Maximum demand of total active power
S1Demand	5084	R	2	Float32	Va	Occurrence time of maximum demand of total active power
S1PeakDemand	5086	R	2	Float32	Va	Maximum apparent power demand of phase A.
S1PeakDemandDate	5088	R	4	Date time	-	Occurrence time of maximum apparent power demand of phase A.
S2Demand	5092	R	2	Float32	Va	Current apparent power demand of phase B.
S2PeakDemand	5094	R	2	Float32	Va	Maximum apparent power demand of phase B.
S2PeakDemandDate	5096	R	4	Date time	-	Occurrence time of maximum apparent power demand of phase B.
S3Demand	5100	R	2	Float32	Va	Current apparent power demand of phase B.
S3PeakDemand	5102	R	2	Float32	Va	Maximum apparent power demand of phase B.
S3PeakDemandDate	5104	R	4	Date time	-	Occurrence time of maximum apparent power demand of phase B.
SSUMDemand	5108	R	2	Float32	Va	Current total apparent power demand.
SSUMPeakDemand	5110	R	2	Float32	Va	Maximum demand of total apparent power.
SSUMPeakDemand Date	5112	R	4	Date time	-	Occurrence time of the maximum demand of total apparent power.
Current demand						
I1Demand	5116	R	2	Float32	A	Phase A current demand.
I1PeakDemand	5118	R	2	Float32	A	Phase A maximum current demand.
I1PeakDemandDate	5120	R	4	Date time	-	Phase A occurrence time of maximum current demand
I2Demand	5124	R	2	Float32	A	Phase B current demand.
I2PeakDemand	5126	R	2	Float32	A	Phase B maximum current demand.

I2PeakDemandDate	5128	R	4	Date time	-	Phase B occurrence time of maximum current demand.
I3Demand	5132	R	2	Float32	A	Phase C current demand.
I3PeakDemand	5134	R	2	Float32	A	Phase C maximum current demand.
I3PeakDemandDate	5136	R	4	Date time	-	Phase C occurrence time of maximum current demand.
IAvgDemand	5140	R	2	Float32	A	Three phase average current demand.
IAvgPeakDemand	5142	R	2	Float32	A	Maximum three phase average current demand.
IAvgPeakDemand Date	5144	R	4	Date time	-	Occurrence time of maximum demand of three-phase average current.

Maximum value

Register alias	Register Starting address (decimal)	operation Read / write	Size	Type	Unit	Description
Current max / min						
I1Max	6000	R	2	Float32	A	Phase A Maximum current
I2Max	6002	R	2	Float32	A	Phase B Maximum current
I3Max	6004	R	2	Float32	A	Phase C Maximum current
I1VGMax	6006	R	2	Float32	A	Maximum three phase average current
I1Min	6010	R	2	Float32	A	Phase A Minimum current
I2Min	6012	R	2	Float32	A	Phase B Minimum current
I3Min	6014	R	2	Float32	A	Phase C Minimum current
I1VGMin	6016	R	2	Float32	A	Minimum three phase average current
Voltage max / min						
U1Max	6020	R	2	Float32	V	U1-UN Maximum phase voltage
U2Max	6022	R	2	Float32	V	U2-UN Maximum phase voltage
U3Max	6024	R	2	Float32	V	U3-UN Maximum phase voltage
Phase UAVGMax	6026	R	2	Float32	V	Maximum value of average value of three-phase phase voltage.
U1Min	6030	R	2	Float32	V	U1-UN Minimum phase voltage
U2Min	6032	R	2	Float32	V	U2-UN Minimum phase voltage

U3Min	6034	R	2	Float32	V	U3-UN Minimum phase voltage
U1VGMin	6036	R	2	Float32	V	Minimum value of average value of three-phase phase voltage.
U12Max	6040	R	2	Float32	V	U1-U2 Maximum wire voltage
U23Max	6042	R	2	Float32	V	U2-U3 Maximum wire voltage
U31Max	6044	R	2	Float32	V	U3-U1 Maximum wire voltage
LineUAVGMax	6046	R	2	Float32	V	Maximum value of average value of three-phase phase voltage.
U12Min	6050	R	2	Float32	V	U1-U2 Minimum phase voltage
U23Min	6052	R	2	Float32	V	U2SS-U3 Minimum phase voltage
U31Min	6054	R	2	Float32	V	U3-U1 Minimum phase voltage
LineUAVGMin	6056	R	2	Float32	V	Minimum value of average value of three-phase phase voltage.
Maximum / minimum power						
P1Max	6060	R	2	Float32	W	Maximum active power of phase A
P2Max	6062	R	2	Float32	W	Maximum active power of phase B
P3Max	6064	R	2	Float32	W	Maximum active power of phase C
PSUMMax	6066	R	2	Float32	W	Maximum value of three-phase total active power
P1Min	6070	R	2	Float32	W	Minimum active power of phase A
P2Min	6072	R	2	Float32	W	Minimum active power of phase B
P3Min	6074	R	2	Float32	W	Minimum active power of phase C
PSUMMin	6076	R	2	Float32	W	Minimum value of three-phase total active power
Reactive Power Max / min						
Q1Max	6080	R	2	Float32	Var	Maximum value of phase A reactive power
Q2Max	6082	R	2	Float32	Var	Maximum value of phase B reactive power
Q3Max	6084	R	2	Float32	Var	Maximum value of phase C reactive power
QSUMMax	6086	R	2	Float32	Var	Maximum value of three-phase total reactive power
Q1Min	6090	R	2	Float32	Var	Minimum value of phase A reactive power
Q2Min	6092	R	2	Float32	Var	Minimum value of phase B reactive power
Q3Min	6094	R	2	Float32	Var	Minimum value of phase C reactive power
QSUMMin	6096	R	2	Float32	Var	Minimum value of three-phase total reactive power
Apparent power max / min						
S1Max	6100	R	2	Float32	Va	Maximum apparent power of phase A
S2Max	6102	R	2	Float32	Va	Maximum apparent power of phase B

S3Max	6104	R	2	Float32	Va	Maximum apparent power of phase C
SSUMMax	6106	R	2	Float32	Va	Maximum three-phase total apparent power
S1Min	6110	R	2	Float32	Va	Minimum apparent power of phase A
S2Min	6112	R	2	Float32	Va	Minimum apparent power of phase B
S3Min	6114	R	2	Float32	Va	Minimum apparent power of phase C
SSUMMin	6116	R	2	Float32	Va	Minimum three phase total apparent power

Unbalance

Register name	register Starting address (decimal)	operation	size	type	Unit	description
Current unbalance						
I1Ubl	7000	R	2	Float32	%	Phase A current unbalance
I2Ubl	7002	R	2	Float32	%	Phase B current unbalance
I3Ubl	7004	R	2	Float32	%	Phase C current unbalance
IwstUbl	7006	R	2	Float32	%	Three phase most unbalanced degree
Voltage unbalance						
U1Ubl	7010	R	2	Float32	%	U1-UN Phase voltage unbalance
U2Ubl	7012	R	2	Float32	%	U2-UN Phase voltage unbalance
U3Ubl	7014	R	2	Float32	%	U3-UN Phase voltage unbalance
PhasewstUbl	7016	R	2	Float32	%	The most unbalanced degree of three phase voltage
U12Ubl	7020	R	2	Float32	%	U1-U2 Unbalance of line voltage
U23Ubl	7022	R	2	Float32	%	U2-U3 Unbalance of line voltage
U31Ubl	7024	R	2	Float32	%	U3-U1 Unbalance of line voltage
LinewstUbl	7026	R	2	Float32	%	Voltage unbalance of three phase