



# NOVUS

REV071013

Johannesburg Branch

MIMIC COMPONENTS

Cape Town Branch

Mimic Cape



## Smart Isolated Temperature Transmitter

# TxIsoRail



## Introduction

**TxIsoRail** is fully programmable isolated temperature transmitters dedicated to Pt100 and thermocouple industrial sensors. **TxIsoRail** is a DIN rail mount unit. Both units can be easily user configured for input type and working range by means of an interface cable connected to a PC USB port.

Why use isolated transmitters?

Isolated transmitters protect the electrical instruments by eliminating ground loop effects and reduce substantially the undesirable interferences and instabilities in sensor measurements.

## Features

TxIsoRail is two-wire signal conditioning devices that deliver 1000 Vac isolation between input and output. These devices can be fully programmed by the end user for different industrial applications. One single model can be configured to accept several thermocouple types and Pt100 RTDs. TxIsoRail can also accept 0 to 50 mV, 0-20 mA and 4-20 mA field signals. The flexibility of in-the-field configuration translates into a one model fits all signal conditioning and isolator module.

## Specifications

- Programmable input: thermocouples type J, K, T, E, N, R, S, B, Pt100 RTD, 0-50 mV, 0-20 mA, 4-20 mA and 0-10 V
- User programmable working range
- 2-wire loop powered 4-20 mA or 20-4 mA output
- 2 or 3-wire Pt100 input with linearized output
- Cold junction compensation for thermocouples
- Option: 0 to 10Vdc
- TxConfig Windows® configurator software
- Configuration with a PC via TxConfig interface
- Manual zero (offset) adjustment can be done by means with 1 front key in the TxIsoRail
- Power supply: 12 to 35 Vdc
- Accuracy: Pt100, 0-50 mV (tension) and 0-20 mA (current)  $\pm 0.20\%$  of full scale. Thermocouples  $\pm 0.25\%$  of full scale  $\pm 1^\circ\text{C}$
- Temperature effect: 0.003% of maximum SPAN/ $^\circ\text{C}$
- Working temperature: -40 to +85  $^\circ\text{C}$  (-40 to 185  $^\circ\text{F}$ )
- Sensor failure protection: programmable burnout upscale or downscale
- Dimensions: 72 mm (H) x 78 mm (D) x 19 mm (W)
- Isolation: 1000 Vac between sensor input and 4-20 mA output loop
- Selectable mains filter: 60 Hz or 50 Hz

## Configuration

Configuration is achieved by means of an interface cable connected to a RS232 PC port along with the convenient configurator software TxConfig. Through this convenient software, the end user can easily configure the input type, the desired working range and the necessary upscale or downscale protections. Minor sensor error corrections can also be made whenever necessary.

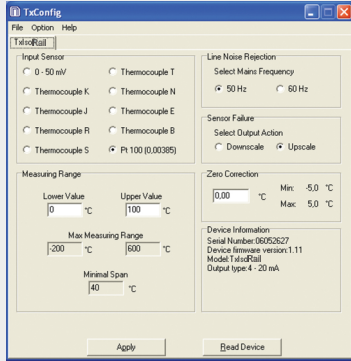

## Input Types and Ranges

Users can easily program input type and temperature range as below:

INPUT	MAX. RANGE	MIN. SPAN
Thermocouple K	-150 to 1370 °C / -238 to 2500 °F	100 °C
Thermocouple J	-100 to 760 °C / -148 to 1400 °F	100 °C
Thermocouple R	-50 to 1760 °C / -58 to 3200 °F	400 °C
Thermocouple S	-50 to 1760 °C / -58 to 3200 °F	400 °C
Thermocouple T	-160 to 400 °C / -256 to 752 °F	100 °C
Thermocouple N	-270 to 1300 °C / 454 to 2372 °F	100 °C
Thermocouple E	-90 to 720 °C / -130 to 1328 °F	100 °C
Thermocouple B	500 to 1820 °C / 932 to 3308 °F	400 °C
Pt100	-200 to 600 °C / -328 to 1112 °F	40 °C
Voltage	0 to 50 mV	5 mV
Voltage	0 to 10 V	1V
Current	0 to 20 mA	2 mA
Current	4 to 20 mA	2 mA

## Block Diagram

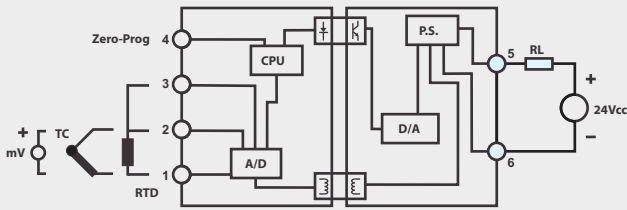

## Load & Power Supply

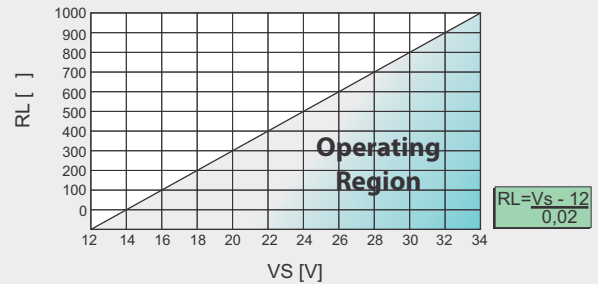

## TxConfig Connections

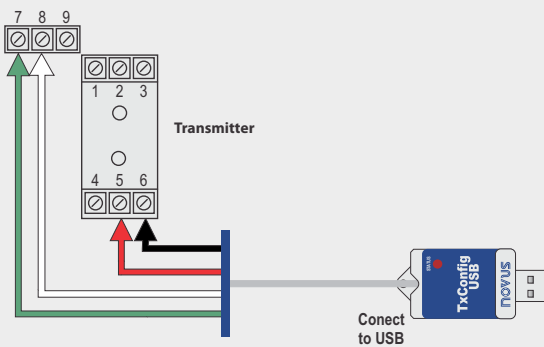

## Dimensions

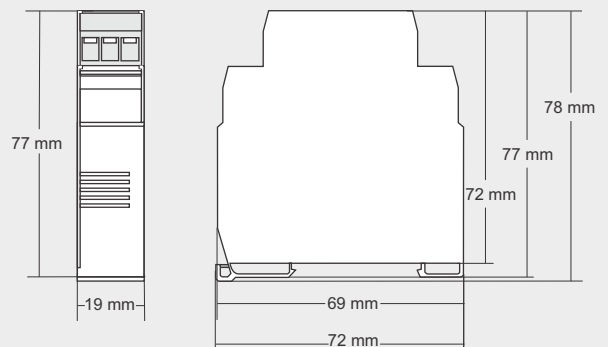

## Electrical Connections

### Pt100

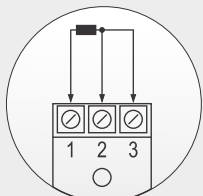

### Thermocouple

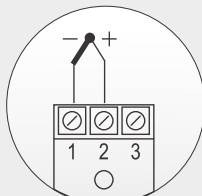

### Output

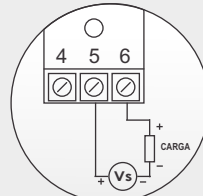

### 4-20 mA

